

Delivering leading edge, innovative power solutions for more than 30 years....

Model:GT-83084-WWVV-USB-W2U

January 28, 2022

Level VI (6) Power Supply / Charger, 5v, 2.0A, for UK with integral USB Jack

Information

Model Number	GT-83084-WWVV-USB-W2U
Description	GT-83084-WWVV-USB-W2U, ICT/ITE Power Supply, Wall Plug-in, AC/DC Switching Adapter with USB Power Supply AC Adaptor, , Input Rating: 100-240V- , 50/60Hz, UK BS 1363, 2 Blade w/Dummy Ground Class II, Output Rating: 10 Watts, Power rating with convection cooling (W) , 5-5.3V in 0.1V increments, Approvals: CB 62368; Double Insulation; EAC; Level VI; RoHS; Ukraine; WEEE; UKCA; SIQ; CE; LPS 62368; SIQ;
Model Picture	
Agency Documents	http://www.globtek.info/certs/GT-83084-USB-W2Z/
CE EC-Declaration	https://www.globtek.com/pdf/ec_declaration/a000c00000QC0fEAD
RoHS/RoHS2 Declaration	https://www.globtek.com/pdf/rohs_cert/a000c00000QC0fEAD
REACH Declaration	https://www.globtek.com/pdf/iso_certificates/REACH.pdf
Conflict Minerals Declaration	https://www.globtek.com/pdf/conflict-minerals.pdf

Delivering leading edge, innovative power solutions for more than **30** years....

Model:GT-83084-WWVV-USB-W2U

January 28, 2022

MODEL PARAMETERS

Type	Wall Plug-in
Technology	AC/DC Switching Adapter with USB Power Supply AC Adaptor
Category	ICT/ITE Power Supply
Input Voltage	100-240V~, 50/60Hz
I/P Amps (A)	0.3A
Wattage (W)	10.0
Vout Range (V)	5-5.3
Efficiency Level	USA DOE Level VI / Eco-design Directive 2009/125/EC, (EU) 2019/1782
Ingress Protection	
Size (mm)	60.9*32.2*48.4 +/-1.0

Delivering leading edge, innovative power solutions for more than 30 years....

Model:GT-83084-WWVV-USB-W2U

January 28, 2022

ENCLOSURE

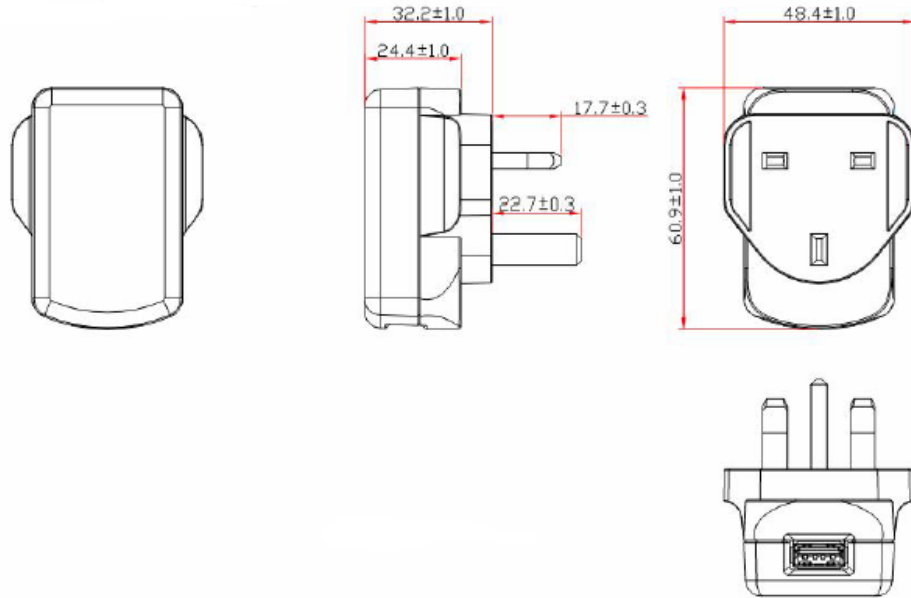

Delivering leading edge, innovative power solutions for more than **30** years....

Model:GT-83084-WWVV-USB-W2U

January 28, 2022

RATING TABLE

Model Number	Voltage	Amps(A)	Watts(W)	RFQ
GT-83084-1106-1.0-USB-W2U	5 V	2.1	10.50	RFQ
GT-83084-1006-1.0-USB-W2U	5 V	2	10.00	RFQ
GT-83084-0806-0.8-USB-W2U	5.2 V	1.5	7.80	RFQ
GT-83084-0806-0.7-USB-W2U	5.3 V	1.5	7.95	RFQ

SPECIFICATIONS

01. Input Voltage: Specified 90-264 Vac, Nameplate rated: 100-240Vac
02. Input Frequency: Specified 47-63 Hz, Nameplate rated 50-60Hz
03. Output Regulation: +/- 5% measured at the end of a 0.6 meter USB cordset employing #22 Gauge conductors
04. Line Voltage Regulation: +/- 1% typical measured at the end of a 0.6 meter USB cordset employing #22 Gauge conductors
05. Output Ripple (Vp-p): +/-1% or 100 mV whichever is greater measured at the end of a 0.6 meter USB cordset employing #22 Gauge conductors. Measured at 20 MHz bandwidth with 0.1 uf ceramic capacitor in parallel with 10 uf electrolytic capacitor connected at the end of the output connector.
06. Hold-up Time: 5 mS minimum
07. Inrush Current: at full load, 25°C, cold start
08. Efficiency: 79% minimum, Meet standard for energy star level: VI, ERP :2009/125/EC

B) PROTECTION

01. Over-current protection: 4A maximum with auto-recovery function
02. Over-voltage protection: 10VDC maximum with zener clamp
03. Short-circuit protection: The adapter shall not be damaged by short the DC output to Ground.

C) SAFETY

01. Dielectric Withstand Voltage: Primary To Secondary: 3000VAC 10mA 1minute or 4242VDC 10mA 1minute
02. Leakage Current: 25mA maximum, at nominal AC input voltage and frequency
03. ESD Immunity per EN61000-4-2, ±8 kV contact, ±15 kV air, Perf Criteria A Standard.

D) EMC

01. Emissions, per EN 55032, EN 61000-6-3, EN 61000-6-4
 - Conducted Emissions: Class B, FCC Part 15, Class B
 - Radiated Emissions: Class B, FCC Part 15, Class B
02. Line Frequency Harmonics EN61000-3-2, Class A
03. Voltage Fluctuations/Flicker EN61000-3-3
04. Immunity, per EN 55024, EN 61000-6-1, EN 61000-6-2
 - Static Discharge Immunity EN61000-4-2, 4kV Contact Discharge, 8kV air discharge
 - Radiated RF Immunity EN61000-4-3, 3V/m 80-1000MHz, 80% 1KHz AM.
 - EFT/Burst Immunity EN61000-4-4, 1kV/100kHz.
 - Line Surge Immunity EN61000-4-5, 1kV differential, 2kV common-mode
 - Conducted RF Immunity EN61000-4-6, 3Vrms, 80% 1KHz AM
 - Power Frequency Magnetic Field Immunity EN61000-4-8, 1A/m
 - Voltage Dip Immunity EN61000-4-11, Criteria

E) OTHER:

01. MTBF: 200,000 Hours @ 25°C ambient temperature
02. Operating Temperature: -10°C to 50°C ambient temperature
03. Operating Humidity: 20 ~ 85 % RH. non-condensing
05. Storage Temperature: -20°C to 60°C
06. Storage Humidity: 5 ~ 95 % RH. non-condensing
07. Cooling: Cooling shall be with natural convection cooling
08. RoHS 2: Complies with EU 2011/65/EU China SJ/T 11364-2014

Delivering leading edge, innovative power solutions for more than **30** years....

Model:GT-83084-WWVV-USB-W2U

January 28, 2022

F) ENCLOSURE

- 01. Housing: High impact plastic, 94V0 polycarbonate, non-vented
 - 02. Markings: Label and/or Pad Printed and/or Molded in the case
-

Delivering leading edge, innovative power solutions for more than 30 years....

Model:GT-83084-WWVV-USB-W2U

January 28, 2022

DERATING CURVE

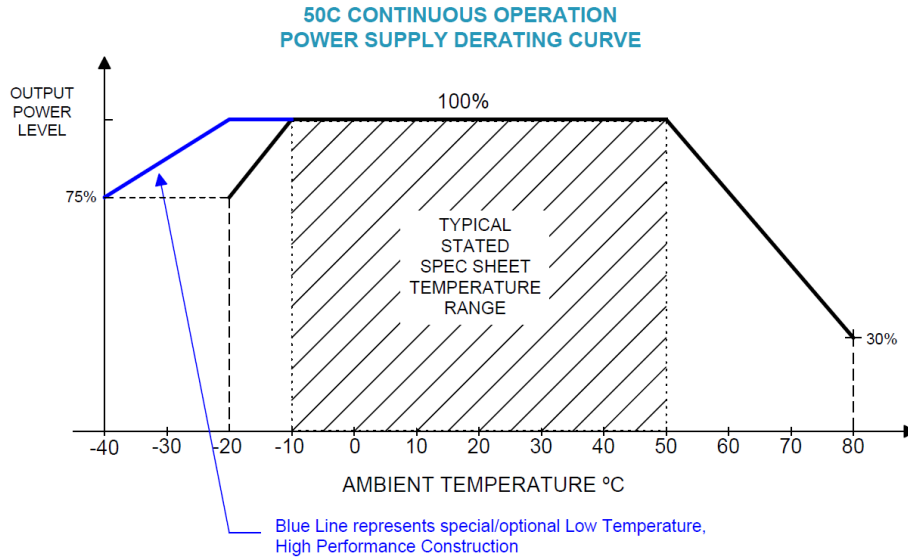

Delivering leading edge, innovative power solutions for more than 30 years....

Model:GT-83084-WWVV-USB-W2U

January 28, 2022

INPUT CONFIGURATION

 Description UK BS 1363, 2 Blade w/Dummy Ground Class II

The line and neutral pins have a rectangular cross section 6.35 mm by 4.0 mm, 17.7 mm long and with centres 22.2 mm apart. The protective-earth pin is a rectangular cross section 8.0 mm by 4.0 mm, 22.3 mm long and with a centre line 22.2 mm from the line/neutral pin centre line. The dimensions were originally specified in decimal inches with asymmetric tolerances and redefined as minimum and maximum metric dimensions in BS 1363:1984.

Dimensions are chosen to provide safe clearance to live parts. The distance from any part of the line and neutral pins to the periphery of the plug base must be not less than 9.5 mm. This ensures that nothing can be inserted alongside a pin when the plug is in use, and helps keep fingers away from the pins. The minimum insertion distance from the face of the socket-outlet to the first point of contact with a live part is 9.6 mm.

The "Dummy" longer earth pin ensures that the earth path is connected before the live pins, and remains connected after the live pins are removed. The earth pin is too large to be inserted into the line or neutral sockets by mistake.

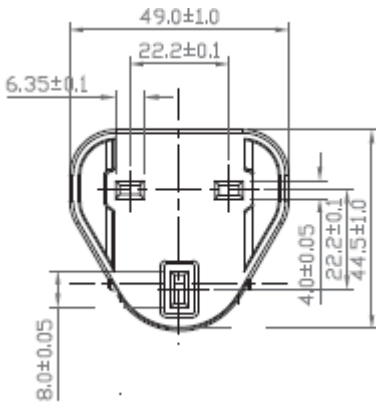

Delivering leading edge, innovative power solutions for more than 30 years....

Model:GT-83084-WWVV-USB-W2U

January 28, 2022

OUTPUT CONFIGURATION

Common output connector options:

 L Type (Coaxial
5.5x2.5mm plug)

 C Type (Coaxial
5.5x2.1mm plug)

 K Type (Coaxial
3.5x1.3mm plug)

 LL Type (5.5x2.5mm
Locking 760k type)

 CL Type (5.5x2.1mm
Locking S761k type)

 ML2 Type (Molex
housing 43025-0200)

 YL3 Type
(KPPX-3P)

YL4 Type (KPPX-4P)

 EJ1/2/3/4/5 (EIAJ
RC-5320A type
connectors)

 MSB Type (Micro
USB)

 USBC Type (USB
Type C)

 Inquire for custom
design

 For a comprehensive list of options, [click here](#)









Contact GlobTek for your specific requirements or custom solutions.

Delivering leading edge, innovative power solutions for more than 30 years....

Model:GT-83084-WWVV-USB-W2U

January 28, 2022



Approvals

Logo	Description
	Attention Mark / Refer to operating manual for operating and service instructions
No Logo Applicable	CB for IEC 62368-1:2014 (Second Edition) + A11:2017
	CE Certification
	
	Declaration ДС № EAЭC N RU Д-US.KA01.B.10453_19 Custom Union of Russia, Belarus and Kazakhstan http://www.globtek.com/redirect/?loc=gost-certificate-eac-declaration
	Indoor Use Only - Mark is on the label or Molded in the case
EFFICIENCY LEVEL 	Efficiency: complies to section 301 of Energy Independence and Security Act (EISA) complies with Energy Star tier 2 (North America), ECP tier 2 (China), MEPS tier 2 (Australia), Code of Conduct (Europe)
LPS	Limited Power Source 62368
RoHS	Specifications of directive 2011/65/EU Annex VI (ROHS-2) with amendment 2015/863-EU (ROHS-3) http://www.ce-mark.com/Rohs%20final.pdf
	SIQ Mark EN 62368-1:2014 + All:2017
 IEC/EN60950-1	SIQ Mark License EN60950-1

Delivering leading edge, innovative power solutions for more than **30** years....

Model:GT-83084-WWVV-USB-W2U

January 28, 2022

	UKCA Certification
 10276	Ukraine UKRSePro (Document: www.globtek.com/html/iso_certificates/GT_Ukraine.pdf)
	WEEE: Complies with EU 2012/19/EU (http://ec.europa.eu/environment/waste/weee/index_en.htm) Mark is on the label or Molded in the case