

Delivering leading edge, innovative power solutions for more than 30 years....

Model:GTM86101-WWVV-W2E

January 23, 2022

## Medical 10W Wall plug in Adapter for Europe, 60601-1 Certified, Europlug Input plug, 2 Prong

### Information

Model Number	GTM86101-WWVV-W2E
Description	GTM86101-WWVV-W2E, ICT / ITE / Medical Power Supply, Wall Plug-in, AC Adaptor Power Supply AC Adaptor, , Input Rating: 100-240V~, 50-60Hz, European CEE 7/16 configuration:EN 50075 Europlug 2 PIN, Output Rating: 12 Watts, Power rating with convection cooling (W) , 5.95-24V in 0.1V increments, Approvals: CB 60601-1; CB 60601-1-11; IP22; CE; China RoHS; Double Insulation; EAC; Level VI; RoHS; Ukraine; VCCI; WEEE; Morocco;

### Model Picture



Agency Documents	<a href="http://www.globtek.info/certs/GTM86101/">http://www.globtek.info/certs/GTM86101/</a>
CE EC-Declaration	<a href="https://www.globtek.com/pdf/ec_declaration/a003a00000LvrrcEAB">https://www.globtek.com/pdf/ec_declaration/a003a00000LvrrcEAB</a>
RoHS/RoHS2 Declaration	<a href="https://www.globtek.com/pdf/rohs_cert/a003a00000LvrrcEAB">https://www.globtek.com/pdf/rohs_cert/a003a00000LvrrcEAB</a>
REACH Declaration	<a href="https://www.globtek.com/pdf/iso_certificates/REACH.pdf">https://www.globtek.com/pdf/iso_certificates/REACH.pdf</a>
Conflict Minerals Declaration	<a href="https://www.globtek.com/pdf/conflict-minerals.pdf">https://www.globtek.com/pdf/conflict-minerals.pdf</a>

Delivering leading edge, innovative power solutions for more than **30** years....

Model:GTM86101-WWVV-W2E

January 23, 2022

**MODEL PARAMETERS**

Type	Wall Plug-in
Technology	AC Adaptor Power Supply AC Adaptor
Category	ICT / ITE / Medical Power Supply
Input Voltage	100-240V~, 50-60Hz
I/P Amps (A)	0.3A
Wattage (W)	12.0
Vout Range (V)	5.95-24
Efficiency Level	USA DOE Level VI / Eco-design Directive 2009/125/EC, (EU) 2019/1782
Ingress Protection	IP22
Size (mm)	69*28.8*58.3

Delivering leading edge, innovative power solutions for more than 30 years....

Model:GTM86101-WWVV-W2E

January 23, 2022

# ENCLOSURE

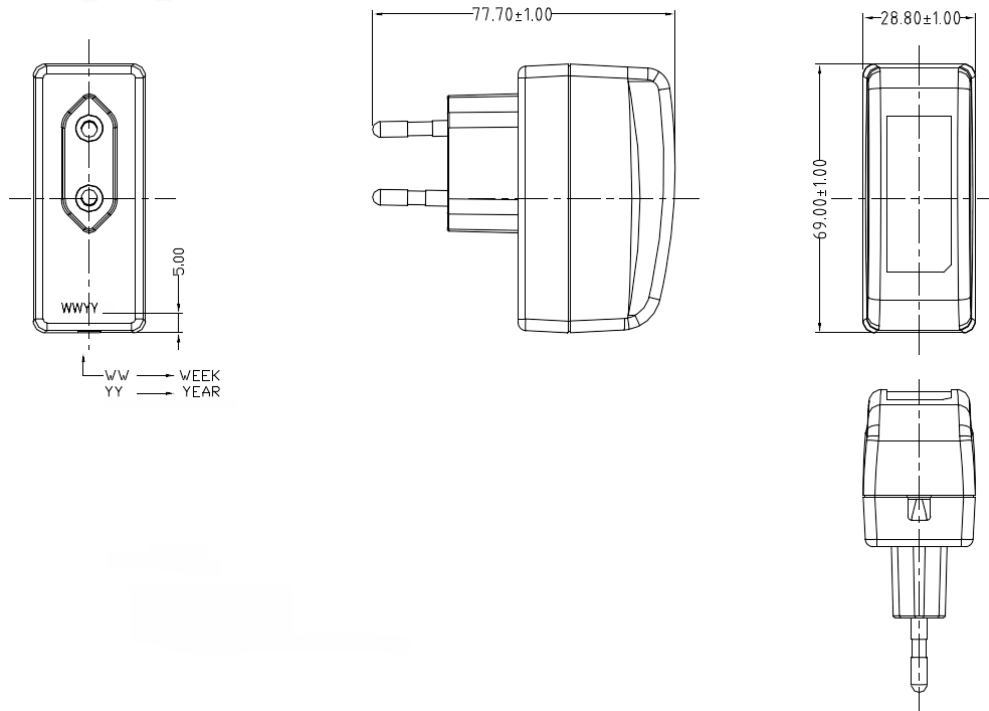

Delivering leading edge, innovative power solutions for more than **30** years....

Model:GTM86101-WWVV-W2E

January 23, 2022

**RATING TABLE**

Model Number	Voltage	Amps(A)	Watts(W)	RFQ
GTM86101-1205.95-W2E	5.95 V	2	11.90	<a href="#">RFQ</a>
GTM86101-1007.5-W2E	7.5 V	1.33	9.98	<a href="#">RFQ</a>
GTM86101-1009-W2E	9 V	1.11	9.99	<a href="#">RFQ</a>
GTM86101-1212-W2E	12 V	1	12.00	<a href="#">RFQ</a>
GTM86101-1215-W2E	15 V	0.8	12.00	<a href="#">RFQ</a>
GTM86101-1224-W2E	24 V	0.5	12.00	<a href="#">RFQ</a>

## SPECIFICATIONS

01. Input Voltage: Specified 90-264 Vac, Nameplate rated: 100-240Vac
02. Input Frequency: Specified 47-63 Hz, Nameplate rated 50/60Hz
03. Output Regulation: +/- 5%
04. Line Voltage Regulation: +/- 1%
05. Output Ripple (Vp-p): 1% or 100 mV whichever is greater, measured at 20 MHz bandwidth with 0.1 uf ceramic capacitor in parallel with a low impedance 47 uf electrolytic capacitor connected at the end of the output connector
06. Hold-up Time: 5 mS minimum
07. Inrush Current: 30A maximum @ 230Vac input
08. Energy Efficiency: Complies to Efficiency Level VI and ErP European Commission's Ecodesign Directive (2005/32/EC) / CoC Tier 2 Compliant

### B) PROTECTION

01. Over-current protection: 110%-140% maximum with auto-recovery function
02. Output Over-Voltage: 110% to 130% of nominal output voltage
03. Short-circuit protection: The adapter shall not be damaged by short the DC output to Ground.

### C) SAFETY

01. Dielectric Withstand Voltage: Primary To Secondary: 4000VAC or 5656VDC for 3 seconds
02. Leakage Current: 50uA maximum, at nominal 240Vac input voltage
03. ESD Immunity per EN61000-4-2, ±8 kV contact, ±15 kV air, Perf Criteria A Standard.

### D) EMC

01. Emissions, per EN 55032, EN 61000-6-3, EN 61000-6-4
  - Conducted Emissions: Class B, FCC Part 15, Class B
  - Radiated Emissions: Class B, FCC Part 15, Class B
02. Line Frequency Harmonics EN61000-3-2, Class A
03. Voltage Fluctuations/Flicker EN61000-3-3
04. Immunity, per EN 55024, EN 61000-6-1, EN 61000-6-2
  - Static Discharge Immunity EN61000-4-2, 8kV Contact Discharge, 15kV air discharge
  - Radiated RF Immunity EN61000-4-3, 3V/m 80-2700MHz, 80% 1KHz AM.
  - EFT/Burst Immunity EN61000-4-4, 2kV/100kHz.
  - Line Surge Immunity EN61000-4-5, 1kV differential, 2kV common-mode
  - Conducted RF Immunity EN61000-4-6, 3Vrms, 80% 1KHz AM
  - Power Frequency Magnetic Field Immunity EN61000-4-8, NA
  - Voltage Dip Immunity EN61000-4-11, Criteria

### E) OTHER:

01. MTBF: 300,000 Hours @ 25°C ambient temperature
02. Operating Temperature: 0°C to 50°C ambient temperature
03. Operating Humidity: 20 ~ 85 % RH. non-condensing
05. Storage Temperature: -20°C to 60°C
06. Storage Humidity: 5 ~ 95 % RH. non-condensing
07. Cooling: Natural convection cooling
08. RoHS 2: Complies with EU 2011/65/EU China SJ/T 11364-2014

Delivering leading edge, innovative power solutions for more than **30** years....

Model:GTM86101-WWVV-W2E

January 23, 2022

## F) ENCLOSURE

01. Housing: High impact plastic, 94V0 polycarbonate, non-vented
02. Markings: Label and/or Pad Printed and/or Molded in the case

## F) OPTIONS:

01. Green Power On Indicator LED
  02. NEMA 1-15P or European Schuko 7-16 AC Plug Configuration
  03. Increased DC Output Voltage (up to 5.4V) to allow for long output cables
  04. Special International Safety Approvals
  05. Housing Color, special markings
-

Delivering leading edge, innovative power solutions for more than 30 years....

Model:GTM86101-WVVV-W2E

January 23, 2022

## DERATING CURVE

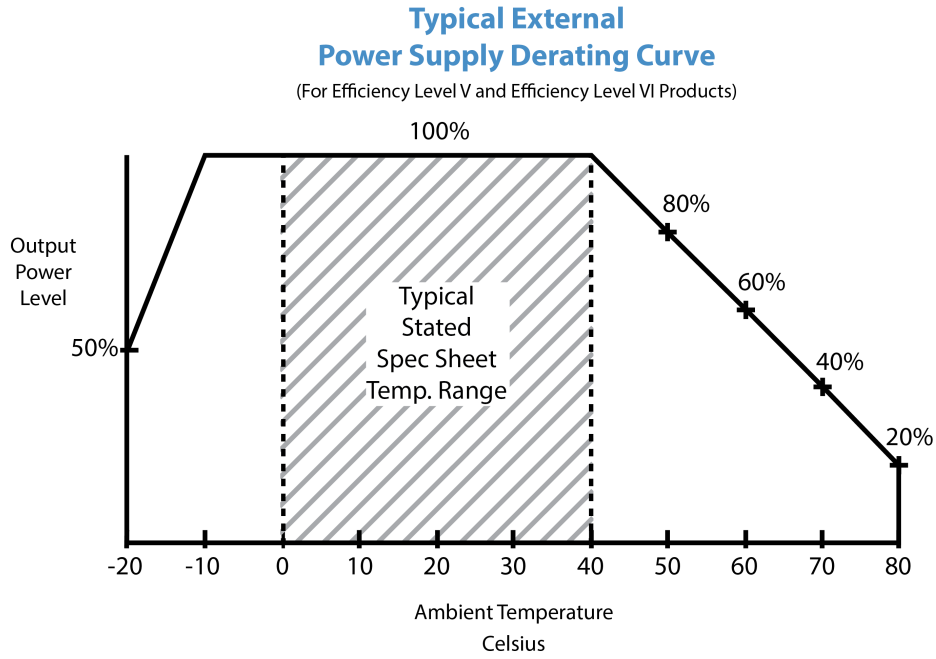

Delivering leading edge, innovative power solutions for more than 30 years....

Model:GTM86101-WVVV-W2E

January 23, 2022

**INPUT CONFIGURATION**Description European CEE 7/16 configuration:EN 50075 Europlug 2 PIN

The prongs of the Europlug are 19 mm long. They consist of a 9 mm long conductive tip of 4 mm diameter with a rounded ending, followed by a 10 mm long flexible insulated shaft of not more than 3.8 mm diameter. The two prongs are not exactly parallel and converge slightly; their centres are 19 mm apart at the tip and 18.6 mm apart at the base. The elasticity of the converging prongs provides sufficient contact force for the Europlug's current rating with a variety of socket-hole arrangements. The entire plug is 35.3 mm wide and 13.7 mm high, and must not exceed these dimensions within 18 mm behind its front plane (this allows for the recesses on many European socket types). The left and right side of the plug are formed by surfaces that are at 45° relative to the horizontal plan.

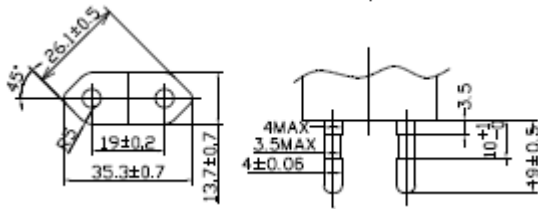



Delivering leading edge, innovative power solutions for more than 30 years....

Model:GTM86101-WVVV-W2E

January 23, 2022

**OUTPUT CONFIGURATION**

Common output connector options:

 L Type (Coaxial  
5.5x2.5mm plug)

 C Type (Coaxial  
5.5x2.1mm plug)

 K Type (Coaxial  
3.5x1.3mm plug)

 LL Type (5.5x2.5mm  
Locking 760k type)

 CL Type (5.5x2.1mm  
Locking S761k type)

 ML2 Type (Molex  
housing 43025-0200)

 YL3 Type  
(KPPX-3P)

YL4 Type (KPPX-4P)

 EJ1/2/3/4/5 (EIAJ  
RC-5320A type  
connectors)

 MSB Type (Micro  
USB)

 USBC Type (USB  
Type C)

 Inquire for custom  
design

 For a comprehensive list of options, [click here](#)







Contact GlobTek for your specific requirements or custom solutions.

Delivering leading edge, innovative power solutions for more than 30 years....

Model:GTM86101-WWVV-W2E

January 23, 2022



## Approvals

Logo	Description
No Logo Applicable	IEC 60601-1-11:2015
No Logo Applicable	IEC 60601-1:2005 (Third Edition) + CORR. 1 (2006) + CORR. 2 (2007) + AM1 (2012) or IEC 60601-1 (2012 reprint) (Ed 3.1) for GTM86101 only
	CE Certification
	CHINA SJ/T 11364-2014, China RoHS Chart: <a href="http://en.globtek.com/globtek-rohs.php">http://en.globtek.com/globtek-rohs.php</a>
	
	Declaration ДС № EAЭC N RU Д-US.KA01.B.10453_19 Custom Union of Russia, Belarus and Kazakhstan <a href="http://www.globtek.com/redirect/?loc=gost-certificate-eac-declaration">http://www.globtek.com/redirect/?loc=gost-certificate-eac-declaration</a>
	Indoor Use Only - Mark is on the label or Molded in the case
IP22	Ingress Protection: IP22 to IEC 60529:1989+A1:1999+A2:2013 Protected against solids objects over 12mm and Protected against vertically (and up to 15°) falling drops of water
EFFICIENCY LEVEL 	Efficiency: complies to section 301 of Energy Independence and Security Act (EISA) complies with Energy Star tier 2 (North America), ECP tier 2 (China), MEPS tier 2 (Australia), Code of Conduct (Europe)
	Morocco SDoC declaration <a href="http://www.globtek.info/certs/Morocco%20SDoC%20Declaration/">http://www.globtek.info/certs/Morocco%20SDoC%20Declaration/</a>

Delivering leading edge, innovative power solutions for more than **30** years....

Model:GTM86101-WWVV-W2E

January 23, 2022

RoHS	Specifications of directive 2011/65/EU Annex VI (ROHS-2) with amendment 2015/863-EU (ROHS-3) <a href="http://www.ce-mark.com/Rohs%20final.pdf">http://www.ce-mark.com/Rohs%20final.pdf</a>
 10276	Ukraine UKRSePro (Document: <a href="http://www.globtek.com/html/iso_certificates/GT_Ukraine.pdf">www.globtek.com/html/iso_certificates/GT_Ukraine.pdf</a> )
	Japan: Voluntary Control Council for Interference (VCCI)
	WEEE: Complies with EU 2012/19/EU ( <a href="http://ec.europa.eu/environment/waste/weee/index_en.htm">http://ec.europa.eu/environment/waste/weee/index_en.htm</a> ) Mark is on the label or Molded in the case