

Delivering leading edge, innovative power solutions for more than **30** years....

Model:GTM964500PWWWVV.V-F

January 23, 2022

GTM964500PWWWVV.V-F

Information

Model Number	GTM964500PWWWVV.V-F
Description	GTM964500PWWWVV.V-F, ICT / ITE / Medical Power Supply, Open Frame/Internal, Regulated Switchmode AC-DC Power Supply AC Adaptor, Forced airflow for full rated power (CFM): 10CFM, Input Rating: 100-240V~, 50-60 Hz, , Output Rating: 450 Watts, Power rating with convection cooling (W) 250W, 12-54V in 0.1V increments, Approvals:

Model Picture

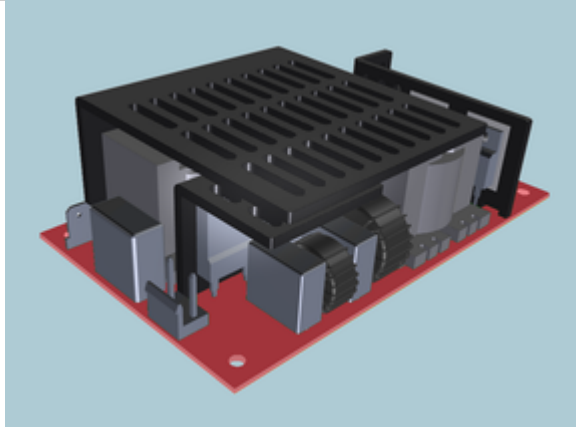

Agency Documents

CE EC-Declaration	https://www.globtek.com/pdf/ec_declaration/a003a00000Ly9m5EAB
RoHS/RoHS2 Declaration	https://www.globtek.com/pdf/rohs_cert/a003a00000Ly9m5EAB
REACH Declaration	https://www.globtek.com/pdf/iso_certificates/REACH.pdf
Conflict Minerals Declaration	https://www.globtek.com/pdf/conflict-minerals.pdf

Delivering leading edge, innovative power solutions for more than **30** years....

Model:GTM964500PWWWVV.V-F

January 23, 2022

MODEL PARAMETERS

Type	Open Frame/Internal
Technology	Regulated Switchmode AC-DC Power Supply AC Adaptor
Category	ICT / ITE / Medical Power Supply
Input Voltage	100-240V~, 50-60 Hz
I/P Amps (A)	6A
Wattage (W)	450.0
Vout Range (V)	12-54
Efficiency Level	USA DOE Level VI / Eco-design Directive 2009/125/EC, (EU) 2019/1782
Ingress Protection	N/A
Size (mm)	127.0 (L) x 76.2 (W) x 38.5 (H)

Delivering leading edge, innovative power solutions for more than 30 years....

Model:GTM964500PWWWVV.V-F

January 23, 2022

ENCLOSURE

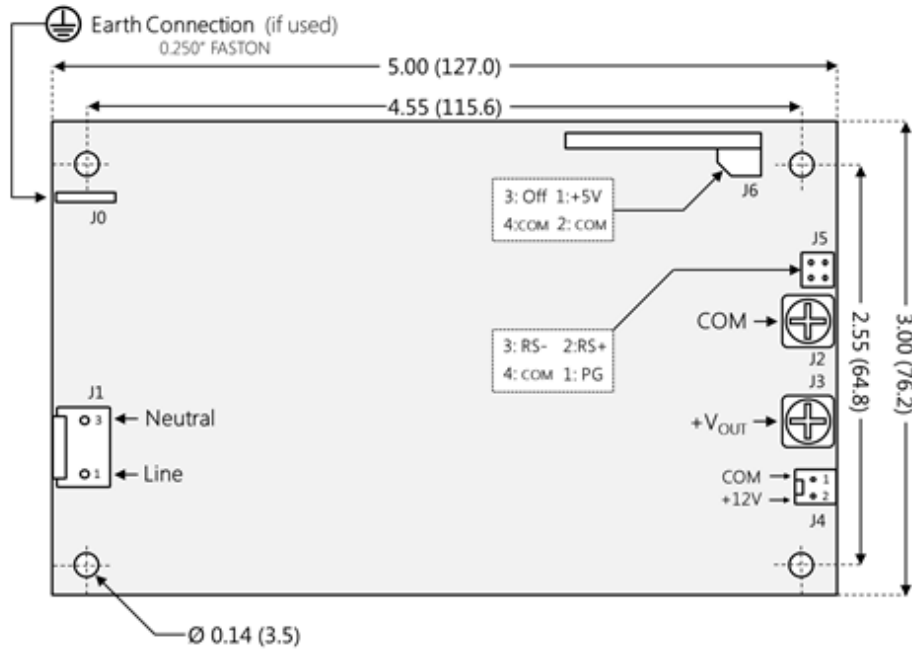

Customer may need to provide EMI shielding if not in metal chassis

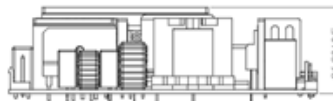
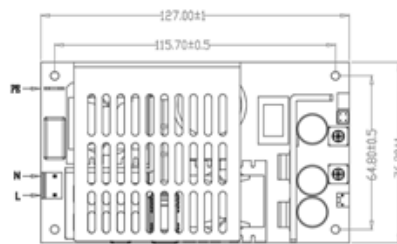

Delivering leading edge, innovative power solutions for more than **30** years....

Model:GTM964500PWWWVV.V-F

January 23, 2022

RATING TABLE

Model Number	Voltage	Amps(A)	Watts(W)	RFQ
--------------	---------	---------	----------	-----

Delivering leading edge, innovative power solutions for more than 30 years....

Model:GTM964500PWWWVV.V-F

January 23, 2022

SPECIFICATIONS

Features

- High power density 3" x 5" format
- Auxiliary +12V fan output
- Auxiliary +5V standby output
- Power-good, remote-off, & remote-sense
- Class I, Class II, or Class II with Functional Earth input configurations
- ITE/ICT and medical (2 x MOPP) certified

Input

Input Voltage:	Specified: 90-264VAC, Nameplate: 100-240VAC
Input Frequency:	Specified: 47-63Hz, Nameplate: 50-60Hz
Input Current:	5.8A typ. @ 90VAC, 2.3A typ. @ 230VAC (full load)
No Load Input Power:	<150mW
Inrush Current:	<35A @ @ 100VAC , <70A @ 230VAC (cold start @ 25°C)
Efficiency:	85 - 95% typ. (full load)
Power Factor:	>0.95 @ 115VAC, >0.90 @ 230VAC (full load)

Output

Output Power:	For 12-18.9V output: 400W (25CFM forced air), 225W (convection), inclusive of fan/aux power For 19-54.0V output: 450W (25CFM forced air), 250W (convection), inclusive of fan/aux power
Turn-on Delay:	< 3 seconds @ 90VAC, < 2 seconds @ 115VAC
Output Voltage Tolerance:	± 2.0% (worst case, set point + load/line regulation)
Load Regulation:	± 0.5% (measured at connector)
Line Regulation:	± 0.2% (measured at connector)
Ripple:	1% pk-pk (using a 47µF low-ESR cap + 0.1µF ceramic capacitor, measured @ 20MHz BW)
Transient Response:	<5% deviation (with 25% load step), recovery to within 1% in 1ms
Startup Overshoot:	<5% (full load)
Hold-up Time:	8ms typ. (full load)
+12V Fan Output:	800mA (max)
+5V Standby Output:	1A (max)

Protections

Input Protection:	MOV transient suppressor, dual fuses (line + neutral)
-------------------	---

PROPRIETARY INFORMATION

PROPRIETARY OF GLOBTEK, INC. ANY REPRODUCTION, DISCLOSURE OR USE OF THIS DRAWING, IN WHOLE OR IN PART, IS HEREBY PROHIBITED EXCEPT AS SPECIFIED IN WRITING BY GLOBTEK, INC.

<https://www.globtek.com/datasheet/w70596>

Delivering leading edge, innovative power solutions for more than 30 years....

Model:GTM964500PWWWVV.V-F

January 23, 2022

Over-Voltage Protection:	110-150%. Latched-off, cycle AC to reset
Over-Current Protection:	105-150% typ. Non-latched with auto-recovery
Short Circuit Protection:	Non-latched with auto-recovery
Over-Temperature Protection:	Latched-off, cycle AC to reset

Environmental

MTBF:	200,000 hours @ 25°C ambient
Operating Temperature:	-20°C to 40°C (Full output power), -40°C to 80°C (Derated)
Storage Temperature:	-40°C to 85°C
Humidity:	0% to 95% relative humidity, non-condensing
Altitude:	5000m max.
Vibration:	Conforms to EN60068-2-6

Safety

Dielectric Withstand Voltage:	4000VAC or 5656VDC from input to output 3000VAC or 4242VDC from input to earth
Intended Medical Application:	Type-B or Type-BF
Touch Current:	NC: <100µA SFC: <500µA
Earth Leakage Current	NC: <0.5mA SFC: <1.0mA
Means of Protection:	2 x MOPP
Primary-Secondary Bridging Capacitance:	Two IEC60384-14 Y1 capacitors in series

EMC

Applicable Standards:	Medical: EN60601-1-2, 4th edition Emissions: EN55032, EN 55011, EN61000-6-3, EN61000-6-4, CISPR11/CISPR22 Immunity: EN55024, EN61000-6-1, EN61000-6-2
Conducted Emissions:	Class B, FCC Part 15, Class B (with resistive load)
Radiated Emissions:	Class B, FCC Part 15, Class B (with resistive load)
Harmonic Current Voltage Distortion:	EN61000-3-2, Class A
Voltage Fluctuations/Flicker:	EN61000-3-3
Electrostatic Discharge (ESD) Immunity:	EN61000-4-2, 10KV contact Discharge, 20KV air discharge (applied to input or output terminals)
Radiated RF Immunity:	EN61000-4-3, 10V/m 80-2700MHz, 80% 1KHz AM.
EFT/Burst Immunity:	EN61000-4-4, 4KV/100kHz.
Line Surge Immunity:	EN61000-4-5, 2KV differential, 4KV common-mode
Conducted RF Immunity:	EN61000-4-6, 3VRMS, 80% 1KHz AM
Power Frequency Magnetic Field Immunity:	EN61000-4-8, 30A/m
Voltage Dip Immunity:	EN61000-4-11

Delivering leading edge, innovative power solutions for more than **30** years....

Model:GTM964500PWWWVV.V-F

January 23, 2022

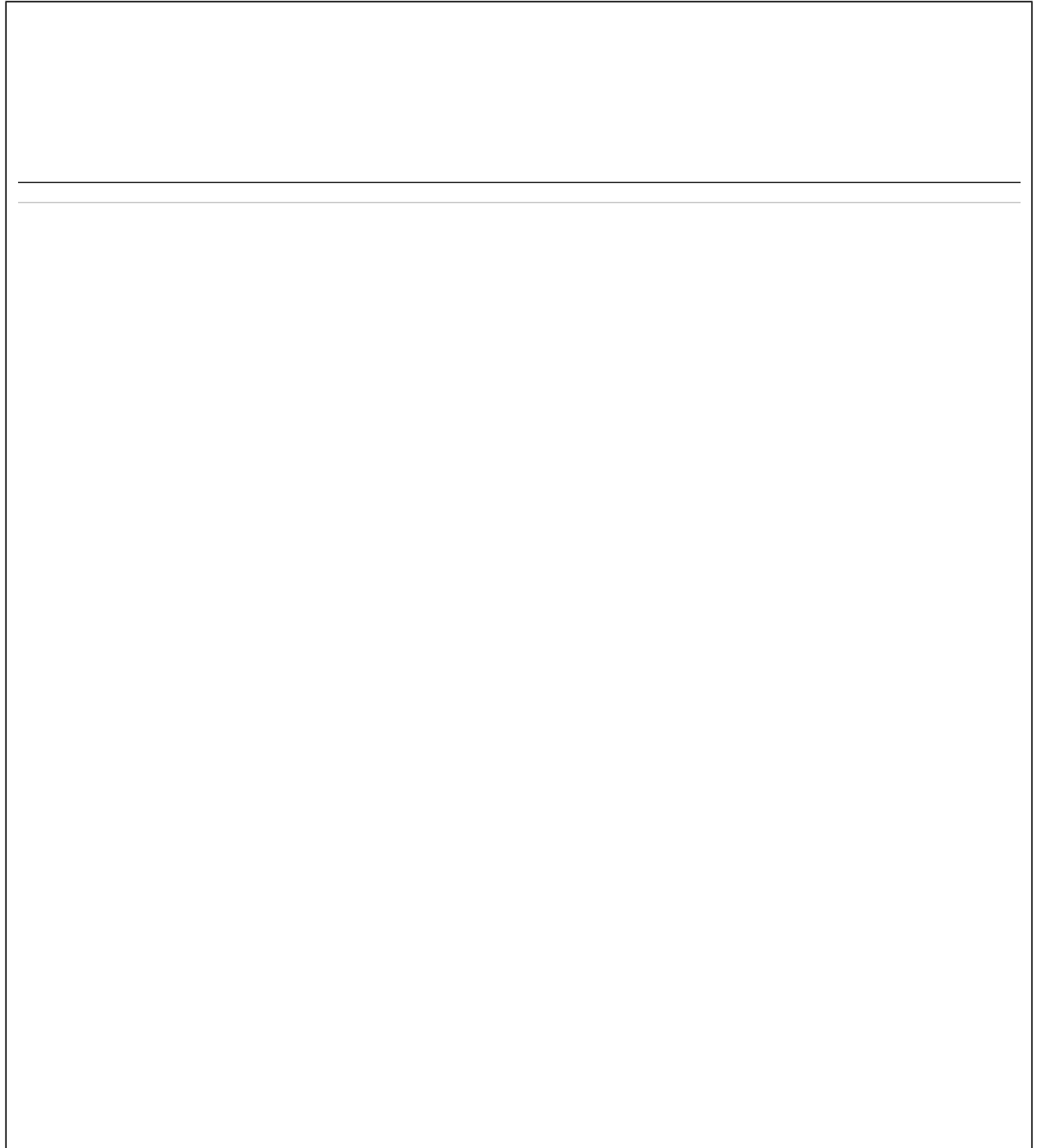

PROPRIETARY INFORMATION

PROPRIETARY OF GLOBTEK, INC. ANY REPRODUCTION, DISCLOSURE OR USE OF THIS DRAWING, IN WHOLE OR IN PART, IS HEREBY PROHIBITED EXCEPT AS SPECIFIED IN WRITING BY GLOBTEK, INC.

<https://www.globtek.com/datasheet/w70596>

Delivering leading edge, innovative power solutions for more than 30 years....

Model:GTM964500PWWWVV.V-F

January 23, 2022

DERATING CURVE

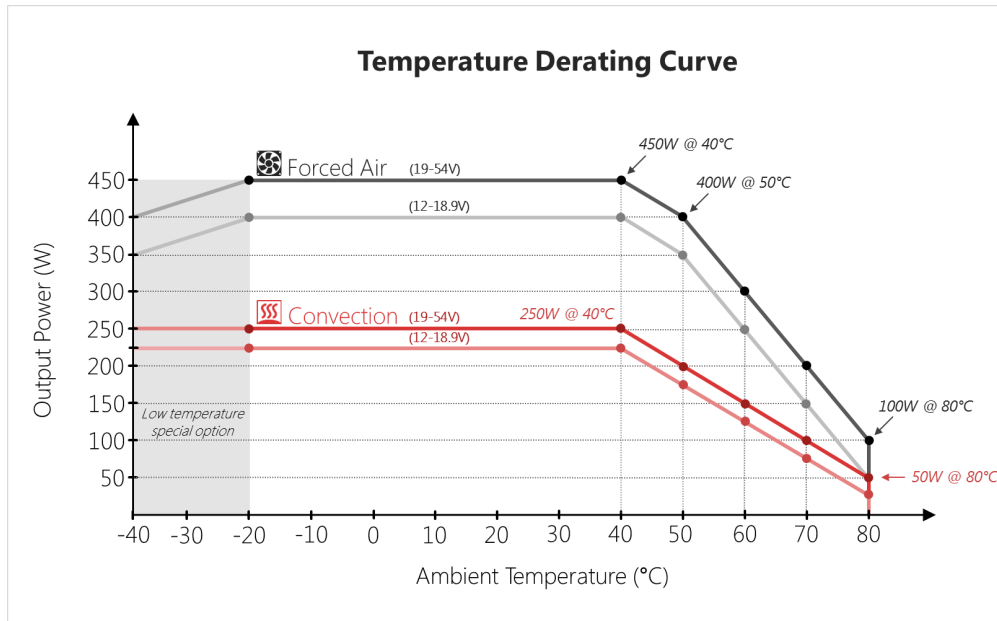
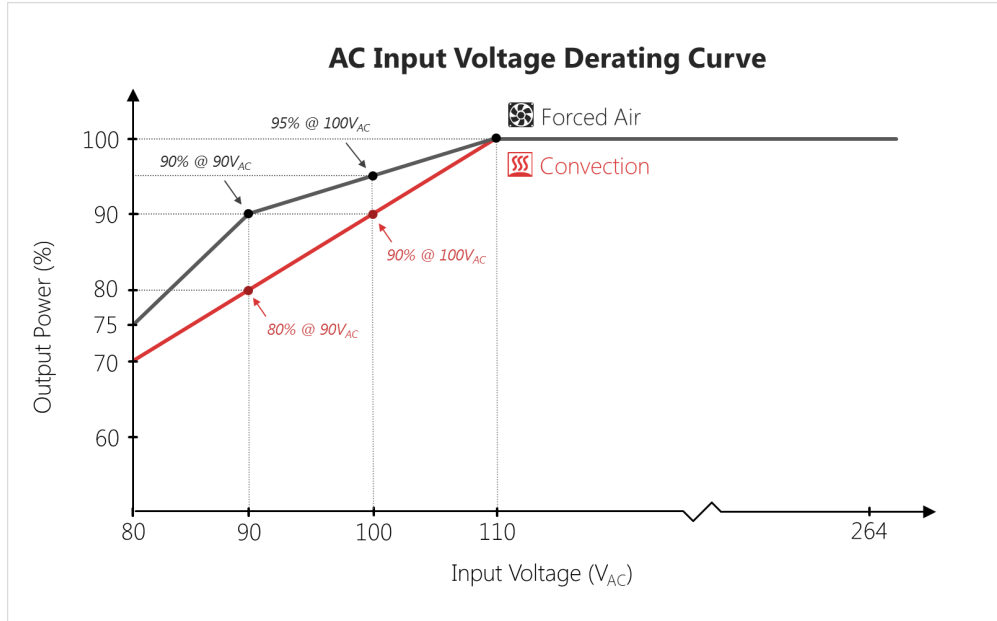

Delivering leading edge, innovative power solutions for more than **30** years....

Model:GTM964500PWWWVV.V-F

January 23, 2022

INPUT CONFIGURATION

Description



Optional Input Wiring Kits are available:

PN/Ordering No	Length	End A	End B
C810070M6VAR2(R)	60	IEC 60320 C8	JST VAR-2
C1410070M6VAR2(R)	60	IEC 60320 C13	JST VAR-2
VAR2210070M7VAR2(R)	73	JST VAR-2	JST VAR-2



Custom lengths, construction, cable types, ferrites, filters, and termination available upon request.

Delivering leading edge, innovative power solutions for more than **30** years....

Model:GTM964500PWWWVV.V-F

January 23, 2022

Approvals

Logo	Description
Conforms to UL STD. 62368-1 Certified to CSA STD C22.2 NO.62368-1	Conforms to UL STD. 62368-1 Certified to CSA STD C22.2 NO.62368-1
	Morocco SDoC declaration http://www.globtek.info/certs/Morocco%20SDoC%20Declaration/
	UKCA Certification