

Delivering leading edge, innovative power solutions for more than 30 years....

Model:GT-83082-3612-W2

January 23, 2022

## GT-83082-3612-W2

### Information

Model Number	GT-83082-3612-W2
Description	GT-83082-3612-W2, ICT/ITE Power Supply, Wall Plug-in, Regulated Switchmode AC-DC; Current Limited Power Supply AC Adaptor, , Input Rating: 100-240V- , 50/60Hz, NEMA 1-15P, North America Blades, Class II 2 Conductors, Output Rating: 36 Watts, Power rating with convection cooling (W) , 12V in 0.1V increments, Approvals: CB 60950; cULus; Double Insulation; Level VI; LPS 60950; PSE; RoHS; VCCI; WEEE;

### Model Picture



Agency Documents	<a href="http://www.globtek.info/certs/GT-83082-W2Z/">http://www.globtek.info/certs/GT-83082-W2Z/</a>
CE EC-Declaration	<a href="https://www.globtek.com/pdf/ec_declaration/a0Oa000000MEww5EAD">https://www.globtek.com/pdf/ec_declaration/a0Oa000000MEww5EAD</a>
RoHS/RoHS2 Declaration	<a href="https://www.globtek.com/pdf/rohs_cert/a0Oa000000MEww5EAD">https://www.globtek.com/pdf/rohs_cert/a0Oa000000MEww5EAD</a>
REACH Declaration	<a href="https://www.globtek.com/pdf/iso_certificates/REACH.pdf">https://www.globtek.com/pdf/iso_certificates/REACH.pdf</a>
Conflict Minerals Declaration	<a href="https://www.globtek.com/pdf/conflict-minerals.pdf">https://www.globtek.com/pdf/conflict-minerals.pdf</a>

Delivering leading edge, innovative power solutions for more than **30** years....

Model:GT-83082-3612-W2

January 23, 2022

**MODEL PARAMETERS**

Type	Wall Plug-in
Technology	Regulated Switchmode AC-DC; Current Limited Power Supply AC Adaptor
Category	ICT/ITE Power Supply
Input Voltage	100-240V~, 50/60Hz
I/P Amps (A)	1.0A
Wattage (W)	36.0
Vout Range (V)	12
Efficiency Level	USA DOE Level VI / Eco-design Directive 2009/125/EC, (EU) 2019/1782
Ingress Protection	
Size (mm)	93*33*78.69+/-0.5

Delivering leading edge, innovative power solutions for more than 30 years....

Model:GT-83082-3612-W2

January 23, 2022

# ENCLOSURE

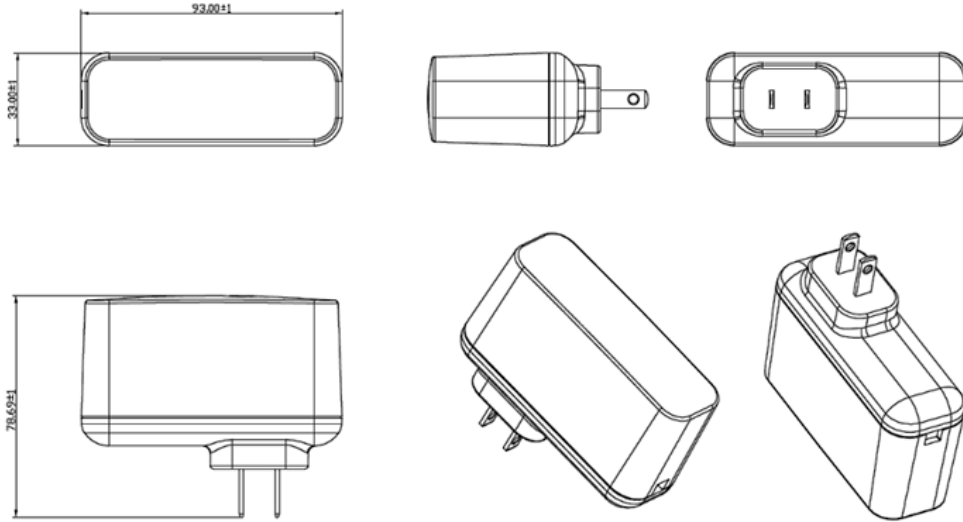

Delivering leading edge, innovative power solutions for more than **30** years....

Model:GT-83082-3612-W2

January 23, 2022

## RATING TABLE

Model Number	Voltage	Amps(A)	Watts(W)	RFQ
GT-83082-3612-W2	12 V	3	36.00	<a href="#">RFQ</a>
GT-83082-3648-W2	48 V	0.75	36.00	<a href="#">RFQ</a>

## SPECIFICATIONS

01. Input Voltage: Specified 90-264 Vac, Nameplate rated: 100-240Vac
02. Input Frequency: Specified 47-63 Hz, Nameplate rated 50-60Hz
03. The adapter input/output are full range AC input and +12V DC with 36 watts maximum output.
04. NOMINAL AC INPUT VOLTAGE 1 A maximum, No damage shall be occurred and the input fuse shall not be blown up.
05. POWER CONSUMPTION: 115VAC/230VAC INPUT , power consumption less than 0.1W
- 06.200 mVp-p maximum Ripple and Noise:At 20 MHz, and output parallel with 0.1uF & 47uF capacitors to ground. Temperature at 25°C, and nominal input voltage (Optional 120 mVp-p maximum Ripple)
07. Turn-ON Delay: 3 Seconds maximum at nominal input voltage
08. Inrush Current: at full load, 25°C, cold start
09. RISE TIME: 100mS maximum at nominal input voltage
- 10.Efficiency: Compliant with Efficiency Level VI and CoC Tier 2 standards
11. No Load Standby Power: <0.075W @ 230Vac
12. Capacitance load ability(CR mode): 12V,Output set CR mode,and 4000uF capacitor @115Vac/60Hz and 230Vac/50Hz ; 0% and 100% load
13. OUTPUT REGULATION +/-5%

### B) PROTECTION

01. Over-current protection
02. Over-voltage protection
03. Short-circuit protection:Short circuit protection is to be included in the construction of the adaptor. The adaptor is designed to withstand continuous current of a short circuit on the output. The adaptor will be short circuit tolerant for an indefinite period.

### C) SAFETY

01. Dielectric Withstand Voltage: Primary To Secondary: 3000VAC 10mA 1minute or 4242VDC 10mA 1minute
02. 0.25mA maximum, at nominal AC input voltage and frequency
03. Touch Current: <0.25mA @ 240Vac input voltage

### D) EMC

01. Emissions, per EN 55032, EN 61000-6-3, EN 61000-6-4
  - Conducted Emissions: Class B, FCC Part 15, Class B
  - Radiated Emissions: Class B, FCC Part 15, Class B
02. Line Frequency Harmonics EN61000-3-2, Class A
03. Voltage Fluctuations/Flicker EN61000-3-3
04. Immunity, per EN 55024, EN 61000-6-1, EN 61000-6-2
  - Static Discharge Immunity EN61000-4-2, 4kV Contact Discharge, 8kV air discharge
  - Radiated RF Immunity EN61000-4-3, 3V/m 80-1000MHz, 80% 1KHz AM.
  - EFT/Burst Immunity EN61000-4-4, 1kV/100kHz.
  - Line Surge Immunity EN61000-4-5, 1kV differential, 2kV common-mode
  - Conducted RF Immunity EN61000-4-6, 3Vrms, 80% 1KHz AM
  - Power Frequency Magnetic Field Immunity EN61000-4-8, 1A/m
  - Voltage Dip Immunity EN61000-4-11, Criteria

Delivering leading edge, innovative power solutions for more than **30** years....

Model:GT-83082-3612-W2

January 23, 2022

## E) OTHER:

- 01. MTBF: 200,000 Hours @ 25°C ambient temperature
- 02. Operating Temperature: -5 °C TO 45 °C
- 03. Operating Humidity: 20 ~ 85 % RH. non-condensing
- 05. Storage Temperature: -20 °C TO +80 °C
- 06. Storage Humidity:5 ~ 95 % RH. non-condensing
- 07. Cooling: Cooling shall be with natural convection cooling
- 08. RoHS 2: Complies with EU 2011/65/EU China SJ/T 11364-2014

## F) ENCLOSURE

- 01. Housing: High impact plastic, 94V0 polycarbonate, non-vented
- 02. Markings: Label and/or Pad Printed and/or Molded in the case

Delivering leading edge, innovative power solutions for more than 30 years....

Model:GT-83082-3612-W2

January 23, 2022

## DERATING CURVE



Delivering leading edge, innovative power solutions for more than **30** years....

Model:GT-83082-3612-W2

January 23, 2022

**INPUT CONFIGURATION**

Description	NEMA 1-15P, North America Blades, Class II 2 Conductors
-------------	---

All NEMA 1 devices are two-wire non-grounding devices (hot-neutral) rated for 125 V maximum. NEMA 1-15P plugs have two parallel flat blades, 0.25 inches (6.35 mm) wide, 0.06 inches (1.524 mm) thick, 0.625-0.718 inches (15.875–18.256 mm) long, and spaced 0.5 inches (12.7 mm) apart.



Delivering leading edge, innovative power solutions for more than 30 years....

Model:GT-83082-3612-W2

January 23, 2022

**OUTPUT CONFIGURATION**

Common output connector options:

 L Type (Coaxial  
5.5x2.5mm plug)

 C Type (Coaxial  
5.5x2.1mm plug)

 K Type (Coaxial  
3.5x1.3mm plug)

 LL Type (5.5x2.5mm  
Locking 760k type)

 CL Type (5.5x2.1mm  
Locking S761k type)

 ML2 Type (Molex  
housing 43025-0200)

 YL3 Type  
(KPPX-3P)

YL4 Type (KPPX-4P)

 EJ1/2/3/4/5 (EIAJ  
RC-5320A type  
connectors)

 MSB Type (Micro  
USB)

 USBC Type (USB  
Type C)

 Inquire for custom  
design









 For a comprehensive list of options, [click here](#)

Contact GlobTek for your specific requirements or custom solutions.

Model:GT-83082-3612-W2

January 23, 2022

## Approvals

Logo	Description
	Attention Mark / Refer to operating manual for operating and service instructions
No Logo Applicable	CB report 60950-1 2nd Ed
	UL60950-1, cULus to UL 60950-1, 2nd Edition, 2007-03-27 and CSA C22.2 No. 60950-1-07, 2nd Edition, 2007-03
	
	Indoor Use Only - Mark is on the label or Molded in the case
 GlobTek, Inc.	JAPAN TUV R-PSE, Cert. No. JD 50473430, to J62368-1(H30) , J55032(H29),J3000(H25)[15V or less]. Please reference the following website for guidelines on PSE regulations: <a href="http://en.globtek.com/importing-ite-and-medical-power-supplies-ac-adaptors-to-japan/">http://en.globtek.com/importing-ite-and-medical-power-supplies-ac-adaptors-to-japan/</a>
EFFICIENCY LEVEL 	Efficiency: complies to section 301 of Energy Independence and Security Act (EISA) complies with Energy Star tier 2 (North America), ECP tier 2 (China), MEPS tier 2 (Australia), Code of Conduct (Europe)
LPS	Limited Power Source 60950
RoHS	Specifications of directive 2011/65/EU Annex VI (ROHS-2) with amendment 2015/863-EU (ROHS-3) <a href="http://www.ce-mark.com/Rohs%20final.pdf">http://www.ce-mark.com/Rohs%20final.pdf</a>
	Japan: Voluntary Control Council for Interference (VCCI)
	WEEE: Complies with EU 2012/19/EU ( <a href="http://ec.europa.eu/environment/waste/weee/index_en.htm">http://ec.europa.eu/environment/waste/weee/index_en.htm</a> ) Mark is on the label or Molded in the case