

Delivering leading edge, innovative power solutions for more than 30 years....

Model:GT-46600-WWVV-X.X-T3A

January 22, 2022

**DOE EPS 2.0 Level VI Power Supply / Charger / AC Adapter, 60W Desktop/Tabletop,
Available with 5-24VDC output Certified to 60950 ITE Standards.**

Information

Model Number	GT-46600-WWVV-X.X-T3A
Description	60 W, DoE Level VI & CoC Tier 2 Efficiency, Three Prong (C6) Inlet, Desktop Adapter, Ac-Dc Power Supply

Model Picture

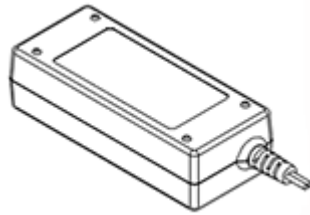

Agency Documents	http://www.globtek.info/certs/GT-46600-60VV-X.X/
CE EC-Declaration	https://www.globtek.com/pdf/ec_declaration/a0Oa000000NruYJEAZ
RoHS/RoHS2 Declaration	https://www.globtek.com/pdf/rohs_cert/a0Oa000000NruYJEAZ
REACH Declaration	https://www.globtek.com/pdf/iso_certificates/REACH.pdf
Conflict Minerals Declaration	https://www.globtek.com/pdf/conflict-minerals.pdf

Delivering leading edge, innovative power solutions for more than **30** years....

Model:GT-46600-WWVV-X.X-T3A

January 22, 2022

MODEL PARAMETERS

Type	Desktop/External
Technology	Regulated Switchmode AC-DC Power Supply AC Adaptor
Category	ICT/ITE Power Supply
Input Voltage	100-240V~, 50-60 Hz
I/P Amps (A)	1.5A
Wattage (W)	60.0
Vout Range (V)	12-24
Efficiency Level	USA DOE Level VI / Eco-design Directive 2009/125/EC, (EU) 2019/1782
Ingress Protection	IPX0
Size (mm)	121*52*33

Delivering leading edge, innovative power solutions for more than **30** years....

Model:GT-46600-WWVV-X.X-T3A

January 22, 2022

ENCLOSURE

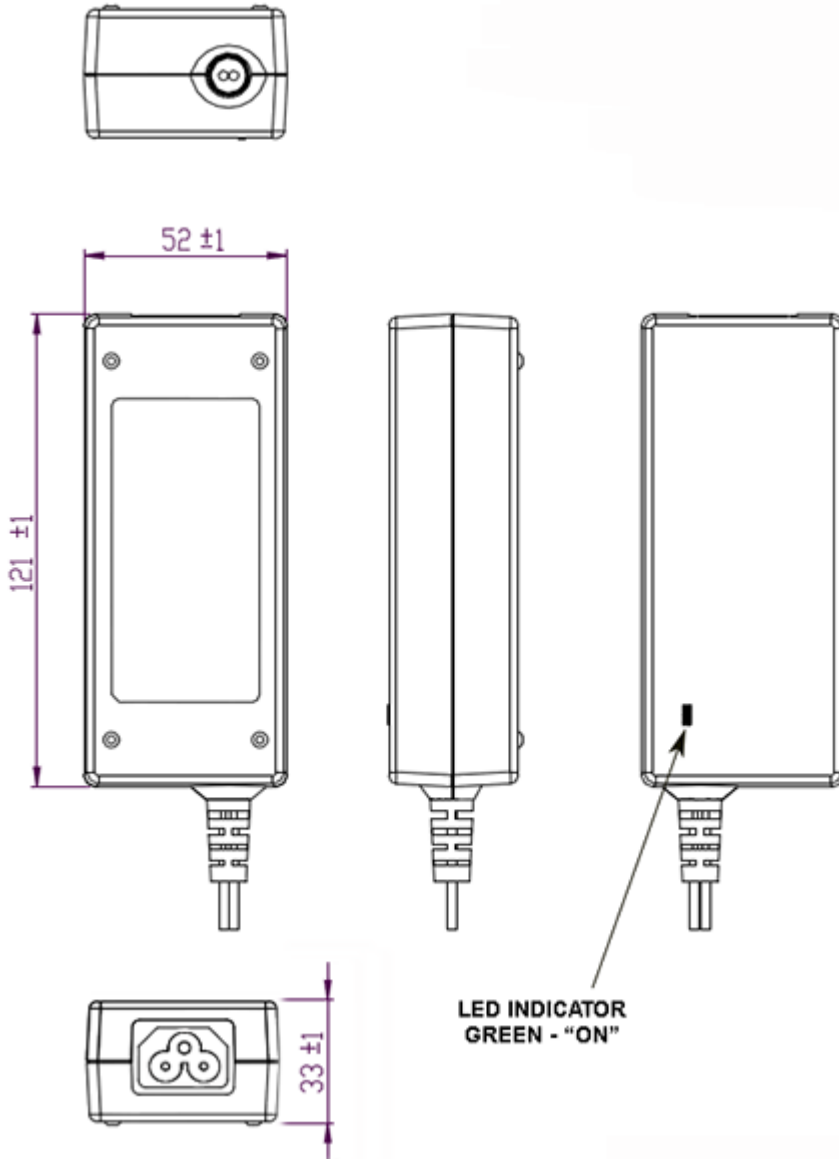

Delivering leading edge, innovative power solutions for more than **30** years....

Model:GT-46600-WWVV-X.X-T3A

January 22, 2022

RATING TABLE

Model Number	Voltage	Amps(A)	Watts(W)	RFQ
GT-46600-6012-T3A	12 V	5	60.00	RFQ
GT-46600-6015-2.0-T3A	13 V	4.61	59.93	RFQ
GT-46600-6015-1.0-T3A	14 V	4.28	59.92	RFQ
GT-46600-6015-T3A	15 V	4	60.00	RFQ
GT-46600-6024-8.0-T3A	16 V	3.75	60.00	RFQ
GT-46600-6024-7.0-T3A	17 V	3.52	59.84	RFQ
GT-46600-6024-6.0-T3A	18 V	3.34	60.12	RFQ
GT-46600-6524-5.0-T3A	19 V	3.42	64.98	RFQ
GT-46600-6524-4.0-T3A	20 V	3.25	65.00	RFQ
GT-46600-6524-3.0-T3A	21 V	3.09	64.89	RFQ
GT-46600-6524-2.0-T3A	22 V	2.95	64.90	RFQ
GT-46600-6524-1.0-T3A	23 V	2.62	60.26	RFQ
GT-46600-6524-T3A	24 V	2.7	64.80	RFQ

SPECIFICATIONS

A) ELECTRICAL SPECIFICATIONS:

01. Input Voltage: Specified 90-264 Vac, Nameplate rated: 100-240Vac
02. Input Frequency: Specified 47-63 Hz, Nameplate rated 50-60Hz
03. Input Rated Current: 1.5A RMS Max
04. Inrush Current: No damage at 240VAC Cold Start
05. Average Efficiency: 88% Min (CEC & DOE LEVEL VI Compliant); 89% Min (ErP European Commission's Ecodesign Directive (2005/32/EC) / CoC Tier 2 Compliant)
06. Input Power(no load): <0.21W (CEC &DOE Level VI Compliant); <0.15W (ErP European Commission's Ecodesign Directive (2005/32/EC) / CoC Tier 2 Compliant)
07. Line regulation: $\pm 1\%$
08. Ripple Voltage: 200mV (p-p) (100-240V AC Input). Measuring is done by 20MHz bandwidth oscilloscope and terminated each output with a 10uf aluminum electrolytic capacitor and 0.1uf ceramic capacitor.

B) PROTECTION

01. Over-Voltage: Electronically Protected Zener clamp across the output
02. Short Circuit: Electronically Protected unit will auto recover upon removal of fault
03. Over Temperature Protection: There shall be no ignition or smoke and deformation of case
04. 08. Over voltage protection: for 12V - 16V; for 15V - 20.25V, for 19V - 25.65, for 24V - 32.4V

C) SAFETY

01. Dielectric Withstand Voltage: 4242Vdc from primary to secondary
02. Earth Leakage Current: <3.5 mA at 240Vac input voltage
03. Touch Current: <0.25mA @ 240Vac input voltage
04. ROHS 2: Complies with EU 2011/65/EU and China SJ/T 11363-2006
05. Earth continuity test:<0.1 Ohm or < 0.2 Ohm when with a non-detachable Power Supply cord, Class I Only

D) OTHER:

01. MTBF: 1,500,000 hours @ 25°C ambient, full load (Telcordia SR-332, Issue 3)
02. Operating Temperature: 0°C to 40°C ambient temperature
03. Humidity: 10% to 90% relative humidity
04. Storage Temperature: -20°C to 70°C
05. Cooling: Convection
06. ROHS 2: Complies with EU 2011/65/EU and China SJ/T 11363-2006

E) ENCLOSURE

01. Housing: High impact plastic, 94V0 polycarbonate, non-vented
02. Size: 121*52*33 +/-1.0 mm
03. Markings: Label and/or Pad Printed and/or Molded in the case

Delivering leading edge, innovative power solutions for more than 30 years....

Model:GT-46600-WWVV-X.X-T3A

January 22, 2022

DERATING CURVE

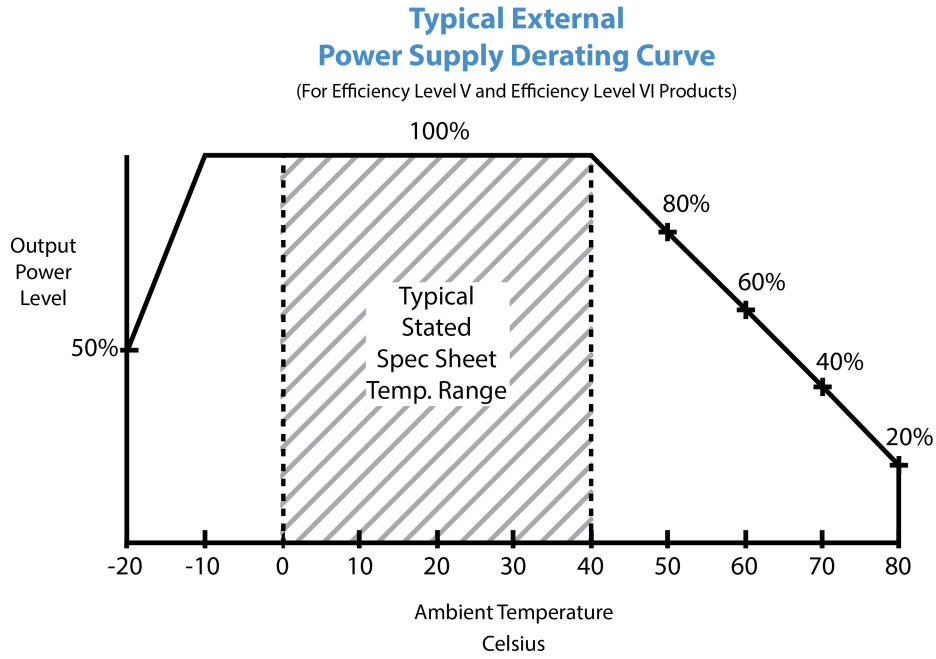

Delivering leading edge, innovative power solutions for more than 30 years....

Model:GT-46600-WWVV-X.X-T3A

January 22, 2022

INPUT CONFIGURATION

Description IEC 60320/C6 AC Inlet Connector, Class I, Earth Ground (aka "Mickey Mouse")

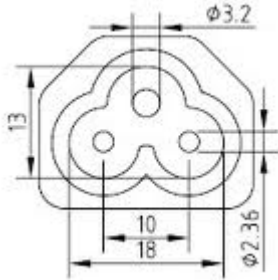

Mates with IEC 60320/C5 Plug

Standard International IEC 320/C5 Cordsets

Below are standard cordsets which are "not included" (unless stated above); these can be purchased separately or package with the power supply. Contact your Sales Engineer if the style required is not shown below. Many more available in different lengths, colors or cable material.

Part Number / Link	Country	Plug	Connector	Length (mm)	Length (ft)
3021066F712(R)	N. American (Type B)	NEMA 5-15P	IEC 320/C5	1880	6
1191068F0712(R)	N. American (Type B)	NEMA 5-15P Hospital	IEC 320/C5	2459	8
2194262M0712(R)	Argentina (Type I)	IRAM 2073	IEC320/C5	2050	6.7
2064262M0712(R)	Australian (Type I)	AS3112 / 3 PRONG	IEC 320/C5	2000	6.6
204B4262M0712(R)	Brazil (Type N)	BRAZIL	IEC 320/C5	2000	6.6
6023592M5712(R)	China (Type I)	CCC GR2099	IEC 320/C5	2500	8
23144262M0712(R)	Europe (Type E)	CEE 7/7	IEC 320/C5	2050	6.6
2313K3432M0712(R)	Korea (Type F)	KS C 8305	IEC 320/C5	2000	6.6
205IN4262M0712(R)	India (Type D)	India IS 1293 (also known as IA16A3 or BS546)	IEC320/C5	2000	6.6
377C4262M0712(R)	Israel (Type H)	ISL	IEC320/C5	2050	6.7
23024262M0712(R)	Italy (Type L)	CEI 23-16/VII	IEC 320/C5	2000	6.6
3003316F0712(R)	Japan (Type B)	JIS 8303 / 3 PINS	IEC 320/C5	1830	6
	Japan / USA	JIS 8303 / 3 PINS +			

Delivering leading edge, innovative power solutions for more than **30** years....

Model:GT-46600-WWVV-X.X-T3A

January 22, 2022

3021066F0712ULPSE(R) (Type B)	NEMA 5-15P	IEC 320/C5 1830	6
2054262M0712(R)	S. Africa (Type D) South Africa SABS164-1 (6A type plug)	IEC320/C5 2050	6.7
2084262M0712(R)	S.Africa (Type M) South Africa SABS164-1 (16A type plug)	IEC 320/C5 2000	6.6
23214262M0712(R)	Switzerland (Type J) SEV 1011 (EL 203)	IEC 320/C5 2000	6.6
3003316F0712(R)	Taiwan (Type B) BSMI	IEC 320/C5 2000	6.6
6104262M0712(R)	UK, Hong Kong, Singapore, Gulf States (Type G) BS1363	IEC 320/C5 2000	6.6

Delivering leading edge, innovative power solutions for more than 30 years....

Model:GT-46600-WWVV-X.X-T3A

January 22, 2022

OUTPUT CONFIGURATION

Common output connector options:



L Type (Coaxial 5.5x2.5mm plug)



C Type (Coaxial 5.5x2.1mm plug)



K Type (Coaxial 3.5x1.3mm plug)



LL Type (5.5x2.5mm Locking 760k type)



CL Type (5.5x2.1mm Locking S761k type)



ML2 Type (Molex housing 43025-0200)



YL3 Type (KPPX-3P)



YL4 Type (KPPX-4P)



EJ1/2/3/4/5 (EIAJ RC-5320A type connectors)



MSB Type (Micro USB)



USBC Type (USB Type C)



Inquire for custom design

For a comprehensive list of options, [click here](#)

Contact GlobTek for your specific requirements or custom solutions.

Delivering leading edge, innovative power solutions for more than 30 years....

Model:GT-46600-WWVV-X.X-T3A

January 22, 2022







Approvals

Logo	Description
No Logo Applicable	EU 230V CoC Tier 2, 278/2009, Mar 2014
	Bureau Of Indian Standards for: GT-46181-0809-3.8-T3, 1209-3.05-T3, 1505-T3, 1605-T3, 1805-T3, 1809-3.05-T3, 1809-T3, 1812-2.0-T3-I812-T3, 1815-T3 GT-46600-6012-T3, 6012-T3A, 6015-1.8-T3, 6015-T3, 6015-T3A, 6024-5.0-T3, 6024-6.0-T3, 6024-T3, 6524-5.0, 6524-T3
	Taiwan BSMI; http://www.bsmi.gov.tw/wSite/ct?xItem=4072&ctNode=8167=2 GT-46600-6012-T3, GT-46600-6015-1.8-T3, GT-46600-6015-1.8-T3A, GT-46600-6015-T3, GT-46600-6012-T3A
No Logo Applicable	IEC 60335-1:2010+A1+A2
No Logo Applicable	IEC 60950-1:2005 +A1:2009 +A2:2013
No Logo Applicable	CB for IEC 62368-1:2014 (Second Edition)
	CCC to GB4943.1-2011; GB/T9254-2008 GB17625.1-2012, Tropical <2000
	CE Certification Class II CE Mark: tested to comply with EN 55032.2012+AC.2013 EN 61000-3-2.2014 EN 61000-3-3.2013 EN 55024.2010
	CE Mark: tested to comply with EN55022:2006/A1:2007 Class B, EN610003-2, EN610003-3 including EN61000-4-2, EN61000-4-3, EN61000-4-4, EN61000-4-5, EN61000-4-6N EN61000-4-11; EMI: Complies with EN55011 CLASS B and FCC Part

Delivering leading edge, innovative power solutions for more than 30 years....

Model:GT-46600-WWVV-X.X-T3A







January 22, 2022

	15B - On label or Molded in case
	CHINA SJ/T 11364-2014, China RoHS Chart: http://en.globtek.com/globtek-rohs.php
Conforms to UL STD. 62368-1 Certified to CSA STD C22.2 NO.62368-1	Conforms to UL STD. 62368-1 Certified to CSA STD C22.2 NO.62368-1
	UL60950-1, cULus to UL 60950-1, 2nd Edition, 2007-03-27 and CSA C22.2 No. 60950-1-07, 2nd Edition, 2007-03
	Declaration ДС № EAЭC N RU Д-US.KA01.B.10453_19 Custom Union of Russia, Belarus and Kazakhstan http://www.globtek.com/redirect/?loc=gost-certificate-eac-declaration
	Compliance of this power supply with FCC Part 15, Class B has been demonstrated with a standard output load. The FCC law stipulates that system-level testing is required to demonstrate compliance with the FCC emission limits with the actual system load.
	Indoor Use Only - Mark is on the label or Molded in the case
EFFICIENCY LEVEL 	Efficiency: complies to section 301 of Energy Independence and Security Act (EISA) complies with Energy Star tier 2 (North America), ECP tier 2 (China), MEPS tier 2 (Australia), Code of Conduct (Europe)
LPS	Limited Power Source 60950
No Logo	Malaysia ST Release Letter GT-46600 T2 -T3A IEC60950-1(Ed.2): 2005 + A1:2009 + A2:2013 No logo
	Morocco SDoC declaration http://www.globtek.info/certs/Morocco%20SDoC%20Declaration/

Delivering leading edge, innovative power solutions for more than 30 years....

Model:GT-46600-WVVV-X.X-T3A



January 22, 2022

	NOM (Mexico) to NOM-001-SCFI-2018 GT-46600-6524-T3; GT-46600-6524-T3A for 24V
	NRCAN Nemko for GT-46600-6012 (12V output) and GT-46600-6015 (15V output) only Natural Resources Canada (NRCAN): CSA Standard C381.1-08, QSP NRCAN EEV1191; http://shop.csa.ca/en/canada/energy-efficiency/canca-c3811-08/inv/27024802008
 Glob Tek, Inc.	JAPAN TUV Rheinland-PSE GlobTek Inc to J60950-1(H26) , J55022(H22),J3000(H25).Please follow the procedure listed in the following link for proper import to Japan: http://en.globtek.com/importing-to-japan.php .
	RCM certificate SAA-210728-EA; Australia and New Zealand Regulatory Compliance, Mark (http://rcm.standards.org.au/rcmfaq/rcmfaq.htm)
RoHS	Specifications of directive 2011/65/EU Annex VI (ROHS-2) with amendment 2015/863-EU (ROHS-3) http://www.ce-mark.com/Rohs%20final.pdf
إمدادات الطاقة	Saudi Arabia approval GT-46600-60VV-X.X-T3 IEC 60950-2005 (output voltage range is 12-24V)
	SGS GS to EN 60950-1:2006 + A11:2009+A1:2010+A12:2011+A2:2013 AFPS GS 2014:01 PAK
	UKCA Certification
 10276	Ukraine UKRSepto (Document: www.globtek.com/html/iso_certificates/GT_Ukraine.pdf)

Delivering leading edge, innovative power solutions for more than **30** years....

Model:GT-46600-WWVV-X.X-T3A

January 22, 2022

	UL 62368-1 and CAN/CSA C22.2 No. 62368-1-14
	Japan: Voluntary Control Council for Interference (VCCI)
	WEEE: Complies with EU 2012/19/EU (http://ec.europa.eu/environment/waste/weee/index_en.htm) Mark is on the label or Molded in the case